

eve aqua 

Get started

Prise en main

Erste Schritte

①

Insert the included AA batteries before proceeding with the installation.

Avant de procéder à l'installation, insérez les piles AA incluses.

Setze die mitgelieferten AA-Batterien ein, bevor du mit der Montage beginnst.

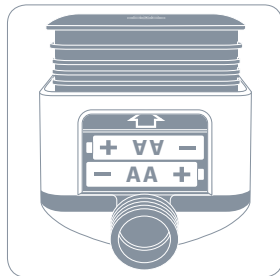
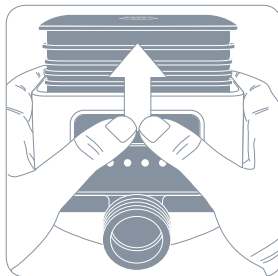
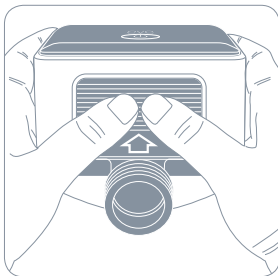

②

Mount Eve Aqua on your faucet and connect a hose.

Installez Eve Aqua sur votre robinet et branchez un tuyau d'arrosage.

Montiere Eve Aqua an deinen Wasserhahn und verbinde den Wasserschlauch.

ⓘ

Attention: Always ensure that Eve Aqua is not exposed to frost.

Attention: Eve Aqua ne doit en aucun cas être exposé au gel.

Achtung: Stelle sicher, dass Eve Aqua keinem Frost ausgesetzt wird.

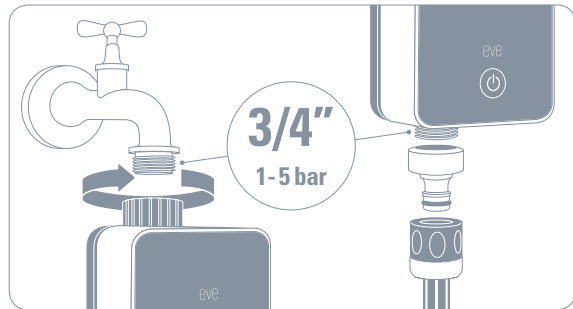

3

Download the Elgato Eve app from the App Store.

Téléchargez l'app Elgato Eve sur l'App Store.

Lade die Elgato Eve App aus dem App Store herunter.

🔍 Elgato Eve



Download on the
App Store



4

Open the Elgato Eve app and tap Add Accessory. Eve will now guide you through the setup process.

Ouvrez l'app Elgato Eve et touchez Ajouter un accessoire. Eve vous guidera alors tout au long du processus de configuration.

Öffne die Elgato Eve App und tippe auf Zubehör hinzufügen. Eve führt dich nun durch die Einrichtung.

Add Accessory

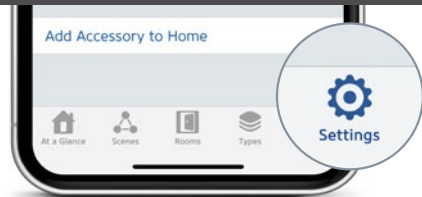

If you have already set up another accessory, go to Settings in Eve to add Eve Aqua to your home.

Si vous avez déjà configuré un autre accessoire, accédez aux réglages d'Eve pour ajouter Eve Aqua à votre domicile.

Wenn du Eve bereits zuvor eingerichtet hast, öffne die Eve-Einstellungen und füge Eve Aqua hinzu.

5

Control Eve Aqua via the app or Siri. You can also press the button to start and stop watering.

Pour contrôler Eve Aqua, utilisez l'app ou Siri. Vous pouvez également appuyer sur le bouton pour activer ou désactiver l'arrosage.

Steuere Eve Aqua über die App oder mit Siri. Du kannst die Bewässerung auch über den Knopf starten und stoppen.

i

Eve Aqua will turn off automatically when the default duration set via the Eve app has expired.

Eve Aqua s'éteindra automatiquement au terme du délai d'exécution par défaut.

Eve Aqua schaltet sich nach Erreichen der in der Eve-App eingestellten Standarddauer automatisch aus.

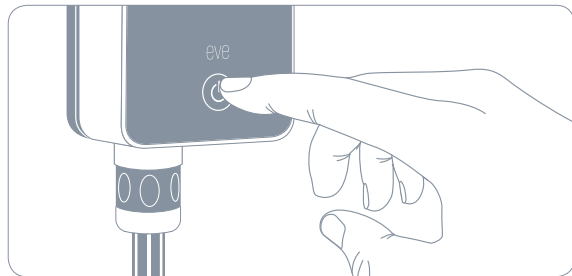

Legal Information • Informations légales • Rechtliche Hinweise

This device complies with part 15 of the FCC Rules and Industry Canada licence-exempt RSS standard(s). Operation is subject to the following two conditions: (1) This device may not cause interference, and (2) this device must accept any interference received, including interference that may cause undesired operation.

This equipment has been tested and found to comply with the limits for a Class B digital device, pursuant to part 15 of the FCC Rules. These limits are designed to provide reasonable protection against harmful interference in a residential installation. This equipment generates, uses and can radiate radio frequency energy and, if not installed and used in accordance with the instructions, may cause harmful interference to radio communications. However, there is no guarantee that interference will not occur in a particular installation. If this equipment does cause harmful interference to radio or television reception, which can be determined by turning the equipment off and on, you are encouraged to try to correct the interference by one or more of the following measures: reorient or relocate the receiving antenna; increase the separation between the equipment and receiver; consult the dealer or an experienced radio/TV technician for help.

This Class B digital apparatus complies with Canadian ICES-003.

This equipment complies with FCC RF and IC RSS-102 radiation exposure limits set forth for an uncontrolled environment. This equipment should be installed and operated with a minimum distance of 0.5 centimeters between the radiator and your body. This transmitter must not be co-located or operating in conjunction with any other antenna or transmitter. The antennas used for this transmitter must be installed to provide a separation distance of at least 0.5 cm from all persons and must not be co-located or operating in conjunction with any other antenna or transmitter.

Changes or modifications not expressly approved by Elgato Systems could void your authority to operate

this device. Purpose of control: operating control; construction of control: plug-in operating control; type 1 action, operating time: continuous.

Le présent appareil est conforme aux CNR d'Industrie Canada applicables aux appareils radio exempts de licence. L'exploitation est autorisée aux deux conditions suivantes : (1) l'appareil ne doit pas produire de brouillage, et (2) l'utilisateur de l'appareil doit accepter tout brouillage radioélectrique subi, même si le brouillage est susceptible d'en compromettre le fonctionnement. Cet appareil numérique de la classe B est conforme à la norme NMB-003 du Canada.

Cet équipement est conforme aux CNR-102 d'Industrie Canada. Cet équipement doit être installé et utilisé avec une distance minimale de 0.5 centimètres entre le radiateur et votre corps. Cet émetteur ne doit pas être co-localisée ou opérant en conjonction avec autre antenne ou émetteur. Les antennes utilisées pour cet émetteur doivent être installés et fournir une distance de séparation d'au moins 0.5 centimètre de toute personne et doit pas être co-située ni fonctionner en conjonction avec une autre antenne ou émetteur.

For questions about Elgato product compliance with FCC regulations, please contact: Compliance Officer, Elgato Systems, 900 Kearny St. #750, San Francisco, CA 94133.

Hereby, Elgato Systems declares that this device is in compliance with the essential requirements and other relevant provisions of Directive 2014/53/EC. The declaration of conformity is available at www.elgato.com/doc

Frequency range: 2402 - 2480 MHz, Max RF e.i.r.p power 3dBm

Temperature range: 3 °C - 50 °C

Product: 10EAI8101, 10EAI4101 • Model: 20EAI8101, 20EAI4101 • Part: 51EAI9901
FCC ID: SNE-WHV-001 • IC: 11192A-WHV001

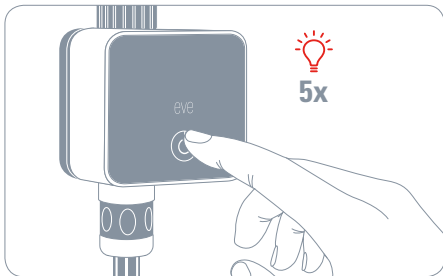

Please keep your HomeKit Setup Code in a safe place. You need it to securely add Eve to your home, and nobody but you has a copy.

Conservez en lieu sûr votre code de configuration HomeKit. Ce code est indispensable pour ajouter Eve au réseau de votre domicile, et personne d'autre que vous ne connaît ce code.

Bewahre deinen HomeKit-Code an einem sicheren Platz auf. Du benötigst ihn, um Eve zu deinem Zuhause hinzuzufügen. Niemand außer dir kennt diesen Code.

Powered by



eve aqua 



Room • Pièce • Zimmer:

Notes • Remarques • Notizen:

